

Hand Sockets 1/4"

2400M • 2400A

6-point Sockets
Vasos Hexagonales

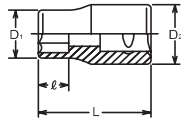

2400M 2405M (mm)	D ₁ (mm)	D ₂ (mm)	ℓ (mm)	L (mm)	(g)	(pcs.)
3	5,5	11,2	2,6	22	7	10
3,5	6,1	11,2	3	22	7	10
4	6,7	11,2	3,5	22	8	10
4,5	7,3	11,2	4	22	8	10
5	8	11,2	5	22	8	10
5,5	8,5	11,2	5,5	22	9	10
6	9,2	11,2	5,5	22	9	10
7	10,3	11,2	6	22	9	10
8	11,2	11,7	6,9	22	11	10
9	13	12	7,3	22	12	10
10	14,3	12,9	7,7	22	15	10
11	15,5	14,3	9,3	22	18	10
12	16,8	15,5	9,3	22	23	10
13	18	16,4	9,8	22	23	10
14	19,3	17,9	11	24	30	10

2405M • 2405A

12-point Sockets
Vasos Bihexagonales

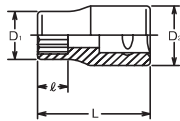

2400A 2405A (inch)	D ₁ (mm)	D ₂ (mm)	ℓ (mm)	L (mm)	(g)	(pcs.)
1/8	5,7	11,2	2,7	22	7	10
5/32	6,7	11,2	3,5	22	8	10
3/16	7,8	11,2	5	22	8	10
7/32	8,5	11,2	5,5	22	9	10
1/4	9,6	11,2	5,8	22	9	10
9/32	10,3	11,2	6	22	9	10
5/16	11,2	11,7	6,9	22	11	10
11/32	12,5	11,7	7,3	22	12	10
3/8	13,7	12,5	7,7	22	15	10
7/16	15,5	14,3	9,3	22	18	10
1/2	18	16,4	9,8	22	23	10
9/16	19,3	17,9	11	24	30	10

RS2400M/11

Socket Set on Rail
Juego de Vasos en Regleta

RS2405M/11



RS2400M/11	11 Pieces Set/Rail 200mm	(g)
4, 5, 6, 7, 8, 9, 10, 11, 12, 13, 14		222

RS2405M/11	11 Pieces Set/Rail 200mm	(g)
4, 5, 6, 7, 8, 9, 10, 11, 12, 13, 14		222

RS2400A/9

Socket Set on Rail
Juego de Vasos en Regleta

RS2405A/9



RS2400A/9	9 Pieces Set/Rail 150mm	(g)
3/16, 7/32, 1/4, 9/32, 5/16, 11/32, 3/8, 7/16, 1/2		162

RS2405A/9	9 Pieces Set/Rail 150mm	(g)
3/16, 7/32, 1/4, 9/32, 5/16, 11/32, 3/8, 7/16, 1/2		162

1/4" Hand Sockets

AS2405A (inch)	D ₁ (mm)	D ₂ (mm)	ℓ (mm)	L (mm)	(g)	(pcs.)
3/16	7.7	10.9	4.5	22	8	10
7/32	8.5	10.9	4.9	22	8	10
1/4	9.4	10.9	5.3	22	8	10
9/32	10.2	10.9	5.5	22	8	10
5/16	11.3	11.7	6.4	22	10	10
11/32	12.5	12	6.8	22	10	10
3/8	13.7	12.9	6.8	22	13	10
7/16	15.6	14.3	8.8	22	17	10
1/2	17.2	16.4	8.9	22	20	10
9/16	18.8	17.9	9.1	24	27	10

Aerospace Standard SAE AS954
Norma Aeroespacial SAE AS954

RSAS2405A/10	10 Pieces Set/Rail 150mm	(g)
3/16, 7/32, 1/4, 9/32, 5/16, 11/32, 3/8, 7/16, 1/2, 9/16		160

2410M (mm)	D ₁ (mm)	D ₂ (mm)	ℓ (mm)	L (mm)	(g)	(pcs.)
4	6.7	11.2	3.5	22	8	10
4.5	7.3	11.2	4	22	8	10
5	8	11.2	5	22	8	10
5.5	8.5	11.2	5.5	22	9	10
6	9.2	11.2	5.5	22	9	10
7	10.3	11.2	6	22	9	10
8	11.2	11.7	6.9	22	11	10
9	13	12	7.3	22	12	10
10	14.3	12.9	7.7	22	15	10
11	15.5	14.3	9.3	22	18	10
12	16.8	15.5	9.3	22	23	10
13	18	16.4	9.8	22	23	10
14	19.3	17.9	11	24	30	10

RS2410M/11	11 Pieces Set/Rail 200mm	(g)
4, 5, 6, 7, 8, 9, 10, 11, 12, 13, 14		222

2400W (BA)	D ₁ (mm)	D ₂ (mm)	ℓ (mm)	L (mm)	(g)	(pcs.)
8	6.1	11.2	3	22	7	10
7	7.3	11.2	4	22	8	10
6	8	11.2	5	22	8	10
5	8.5	11.2	5.5	22	9	10
4	9.6	11.2	5.8	22	9	10
3	10.3	11.2	6	22	9	10
2	11.2	11.7	6.9	22	11	10
1	13	12	7.3	22	12	10
0	14.9	13.6	8	22	16	10

BA



	BA	8BA	7BA	6BA	5BA	4BA	3BA	2BA	1BA	0BA
Across Flat (ref. mm)		3.86	4.37	4.90	5.59	6.30	7.16	8.23	9.27	10.49
Across Flat (ref. inch)		0.152	0.172	0.193	0.220	0.248	0.282	0.324	0.365	0.413

RS2400W/9-BA	9 Pieces Set/Rail 150mm	(g)
8, 7, 6, 5, 4, 3, 2, 1, 0		120

AS2405A 12-point Sockets, AS954 Vasos Bihexagonales

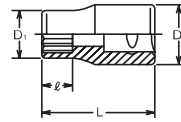

RSAS2405A/10 Socket Set on Rail Juego de Vasos en Regleta



2410M Surface Drive Sockets Vasos Surface Drive (de Contacto Curvo)

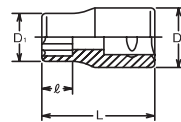

RS2410M/11 Socket Set on Rail Juego de Vasos en Regleta



2400W-BA 6-point Sockets Vasos Hexagonales

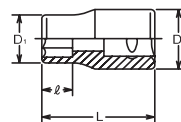

RS2400W/9-BA Socket Set on Rail Juego de Vasos en Regleta



HAND MANUALES
Z-SERIES
TITANIUM DE TITANIO
ACCESSORIES ACCESORIOS
SCREWDRIVERS DESTORNILLADORES
IMPACT DE IMPACTO
SLEEVE-DRIVE
INDUSTRIAL INDUSTRIALES
PROTECTOR PROTECTORES
AUTOMOTIVE
CONSTRUCTION CONSTRUCCIÓN
RENEWAL KITS JUEGOS DE REZAS/REPERIENDO

Hand Sockets 1/4"

HAND
MANUALES

Z-SERIES

TITANIUM
DE TITANIO

ACCESSORIES
ACCESORIOS

SCREWDRIVERS
DESTORNILLADORES

IMPACT
DE IMPACTO

SLEEVE-DRIVE

INDUSTRIAL
INDUSTRIALES

PROTECTOR
PROTECTORES

AUTOMOTIVE

CONSTRUCTION
CONSTRUCCIÓN

RENEWAL KITS
JUEGOS DE PIEZAS REPUESTO

2415M • 2415A



Double Square Sockets
Vasos Octagonales

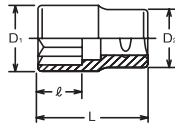

2415M (mm)	D ₁ (mm)	D ₂ (mm)	ℓ (mm)	L (mm)	(g)	(pcs.)
6	11	11.7	5.4	22	13	10
8	14.3	12.9	6.8	22	17	10
10	17.4	16	8.2	22	27	10

2415A (inch)	D ₁ (mm)	D ₂ (mm)	ℓ (mm)	L (mm)	(g)	(pcs.)
1/4	11	11.7	5.4	22	14	10
5/16	14.3	12.9	6.8	22	17	10
3/8	17.4	16	8.2	22	26	10

2425



TORX® Sockets
Vasos TORX®



2425 (E)	D ₁ (mm)	D ₂ (mm)	ℓ (mm)	L (mm)	(g)	(pcs.)
E 4	5.4	11.2	4.6	22	7	10
E 5	6.7	11.2	5.2	22	8	10
E 6	7.7	11.2	5.4	22	8	10
E 7	8.3	11.2	6.6	22	9	10
E 8	9.6	11.2	7	22	9	10
E10	11.3	12	8.2	22	10	10

RS2425/6



Socket Set on Rail
Juego de Vasos en Regleta



RS2425/6	6 Pieces Set/Rail 150mm	(g)
E4, E5, E6, E7, E8, E10		85

2450MS



Nut Grip Sockets
Vasos Sujeta-tuercas Nut Grip®

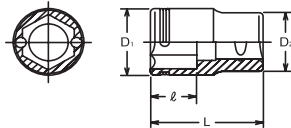

2450MS (mm)	D ₁ (mm)	D ₂ (mm)	ℓ (mm)	L (mm)	(g)	(pcs.)
7	11.3	11.2	4	18	8	10
8	12.3	11.2	5	18	9	10
10	14.3	12.9	6	19	13	10
12	17.4	16	7	20	22	10
13	18	16.4	8	20	22	10
14	19.9	18	8.5	22	31	10

RS2450MS/6



Socket Set on Rail
Juego de Vasos en Regleta



RS2450MS/6	6 Pieces Set/Rail 150mm	(g)
7, 8, 10, 12, 13, 14		120

2300X



6-point Sockets, Semi-Deep
Vasos Hexagonales, Medianos

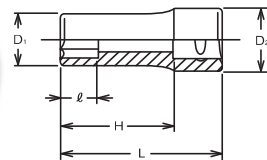

2300X (mm)	D ₁ (mm)	D ₂ (mm)	ℓ (mm)	H (mm)	L (mm)	(g)	(pcs.)
4	6.7	11.2	4	22	32	10	10
5	8	11.2	5.5	22	32	11	10
6	9.2	11.2	7	22	32	12	10
7	10.5	11.2	8	22	32	13	10
8	11.8	11.2	9	22	32	16	10
9	13	12	10	22	32	18	10
10	14.3	12.9	11	21	32	23	10
11	15.5	14.3	12	21	32	27	10
12	16.8	15.5	13	21	32	29	10
13	18	16.4	14	21	32	32	10
14	19.3	17.9	16	20	32	37	10

RS2300X/11



Socket Set on Rail
Juego de Vasos en Regleta



RS2300X/11	11 Pieces Set/Rail 200mm	(g)
4, 5, 6, 7, 8, 9, 10, 11, 12, 13, 14		300

2350X



Nut Grip® Socket, Semi-Deep
Vasos Sujeta-tuercas Nut Grip®. Medianos

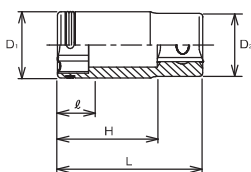

2350X (mm)	D ₁ (mm)	D ₂ (mm)	ℓ (mm)	H (mm)	L (mm)	(g)	(pcs.)
New 8	12.3	11.2	5	22	32	17	10
New 10	14.2	12.9	6	22	32	22	10
New 12	17.3	16	7	22	32	34	10
New 14	20	18	8.5	22	32	43	10

1/4" Hand Sockets

2300M 2305M (mm)	D ₁ (mm)	D ₂ (mm)	ℓ (mm)	H (mm)	L (mm)	(g)	(pcs.)
3	5.5	11.2	3	40	50	15	10
4	6.7	11.2	4	40	50	15	10
4.5	7.3	11.2	4.5	40	50	15	10
5	8	11.2	5.5	40	50	17	10
5.5	8.5	11.2	6	40	50	17	10
6	9.2	11.2	7	40	50	20	10
7	10.5	11.2	8	40	50	25	10
8	11.8	11.2	9	40	50	25	10
9	13	12	10	40	50	30	10
10	14.3	12.9	11	39	50	34	10
11	15.5	14.3	12	39	50	43	10
12	16.8	15.5	13	39	50	50	10
13	18	16.4	14	39	50	52	10
14	19.3	17.9	16	38	50	57	10

2300A 2305A (inch)	D ₁ (mm)	D ₂ (mm)	ℓ (mm)	H (mm)	L (mm)	(g)	(pcs.)
1/8	5.7	11.2	3.5	40	50	15	10
5/32	6.7	11.2	4	40	50	15	10
3/16	7.8	11.2	5.5	40	50	17	10
7/32	8.5	11.2	6	40	50	17	10
1/4	9.8	11.2	7	40	50	25	10
9/32	10.5	11.2	8	40	50	25	10
5/16	11.8	11.2	9	40	50	25	10
11/32	12.5	11.7	10	40	50	30	10
3/8	13.7	12.5	11	40	50	34	10
7/16	15.5	14.3	12	39	50	43	10
1/2	18	16.4	14	39	50	52	10
9/16	19.3	17.9	16	38	50	57	10

RS2300M/11	11 Pieces Set/Rail 200mm	(g)
4, 5, 6, 7, 8, 9, 10, 11, 12, 13, 14		437

RS2305M/11	11 Pieces Set/Rail 200mm	(g)
4, 5, 6, 7, 8, 9, 10, 11, 12, 13, 14		437

RS2300A/9	9 Pieces Set/Rail 150mm	(g)
3/16, 7/32, 1/4, 9/32, 5/16, 11/32, 3/8, 7/16, 1/2		296

RS2305A/9	9 Pieces Set/Rail 150mm	(g)
3/16, 7/32, 1/4, 9/32, 5/16, 11/32, 3/8, 7/16, 1/2		296

2300W (BA)	D ₁ (mm)	D ₂ (mm)	ℓ (mm)	H (mm)	L (mm)	(g)	(pcs.)
4	9.8	11.2	7	40	50	22	10
3	10.5	11.2	8	40	50	25	10
2	11.8	11.2	9	40	50	25	10
1	13	12	10	40	50	30	10
0	14.9	13.6	12	39	50	38	10

BA	Across Flat									
	BA	8BA	7BA	6BA	5BA	4BA	3BA	2BA	1BA	0BA
	(ref. mm)	3.86	4.37	4.90	5.59	6.30	7.16	8.23	9.27	10.49
	(ref. inch)	0.152	0.172	0.193	0.220	0.248	0.282	0.324	0.365	0.413

2300M · 2300A 6-point Deep Sockets Vasos Hexagonales Largos

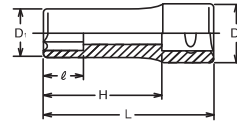

2305M · 2305A 12-point Deep Sockets Vasos Bihexagonales Largos

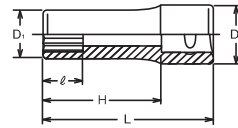

RS2300M/11 Socket Set on Rail RS2305M/11 Juego de Vasos en Regleta



RS2300A/9 Socket Set on Rail RS2305A/9 Juego de Vasos en Regleta



2300W-BA 6-point Deep Sockets Vasos Hexagonales Largos

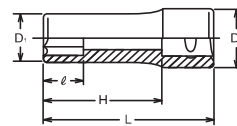

HAND
MANUALES
Z-SERIES
TITANIUM
DE TITANIO
ACCESSORIES
ACCESORIOS
SCREWDRIVERS
DESTORNILLADORES
IMPACT
DE IMPACTO
SLEEVE-DRIVE
INDUSTRIAL
INDUSTRIALES
PROTECTOR
PROTECTORES
AUTOMOTIVE
CONSTRUCTION
CONSTRUCCIÓN
RENEWAL KITS
JUEGOS DE REZAS REPUESTO

Hand Sockets 1/4"

HAND
MANUALES

Z-SERIES

TITANIUM
DE TITANIO

ACCESSORIES
ACCESORIOS

SCREWDRIVERS
DESTORNILLADORES

IMPACT
DE IMPACTO

SLEEVE-DRIVE

INDUSTRIAL
INDUSTRIALES

PROTECTOR
PROTECTORES

AUTOMOTIVE

CONSTRUCTION
CONSTRUCCIÓN

RENEWAL KITS
JUEGOS DE PIEZAS REPUESTO

AS2305A

12-point Deep Sockets, AS954
Vasos Bihexagonales Largos, AS954

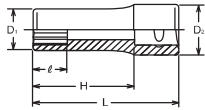

RSAS2305A/10

Socket Set on Rail
Juego de Vasos en Regleta



2310M

Surface Drive Deep Sockets
Vasos Surface Drive (de Contacto Curvo) Largos

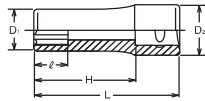

RS2310M/11

Socket Set on Rail
Juego de Vasos en Regleta



2325

TORX® Deep Sockets
Vasos TORX® Largos

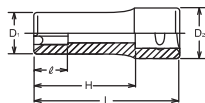

2350M

Nut Grip Deep Sockets Nut Grip®
Vasos Sujeta-tuercas Largos Nut Grip®

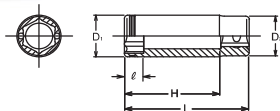

AS2305A (inch)	D ₁ (mm)	D ₂ (mm)	ℓ (mm)	H (mm)	L (mm)	(g)	(pcs.)
3/16	7.7	10.9	4.5	40	50	17	10
7/32	8.5	10.9	4.9	40	50	17	10
1/4	9.4	10.9	5.3	40	50	19	10
9/32	10.2	10.9	5.5	40	50	18	10
5/16	11.3	11.7	6.4	40	50	23	10
11/32	12.5	12	6.8	40	50	24	10
3/8	13.7	12.8	6.8	39	50	31	10
7/16	15.6	14.2	8.8	39	50	38	10
1/2	17.2	16.2	8.9	39	50	42	10
9/16	18.8	17.1	9.1	38	50	47	10

Aerospace Standard SAE AS954
Norma Aeroespacial SAE AS954

RSAS2305A/10	10 Pieces set/Rail 150mm	(g)
3/16, 7/32, 1/4, 9/32, 5/16, 11/32, 3/8, 7/16, 1/2, 9/16		307

2310M (mm)	D ₁ (mm)	D ₂ (mm)	ℓ (mm)	H (mm)	L (mm)	(g)	(pcs.)
3	5.5	11.2	3	40	50	15	10
4	6.7	11.2	4	40	50	15	10
4.5	7.3	11.2	4.5	40	50	15	10
5	8	11.2	5.5	40	50	17	10
5.5	8.5	11.2	6	40	50	17	10
6	9.2	11.2	7	40	50	20	10
7	10.5	11.2	8	40	50	25	10
8	11.8	11.2	9	40	50	25	10
9	13	12	10	40	50	30	10
10	14.3	12.9	11	39	50	34	10
11	15.5	14.3	12	39	50	43	10
12	16.8	15.5	13	39	50	50	10
13	18	16.4	14	39	50	52	10
14	19.3	17.9	16	38	50	57	10

RS2310M/11	11 Pieces set/Rail 200mm	(g)
4, 5, 6, 7, 8, 9, 10, 11, 12, 13, 14		437

2325 (E)	D ₁ (mm)	D ₂ (mm)	ℓ (mm)	H (mm)	L (mm)	(g)	(pcs.)
E 4	5.4	12	4.6	40	50	17	10
E 5	6.8	12	5.2	40	50	20	10
E 6	8	12	5.4	40	50	20	10
E 7	8.3	12	6.6	40	50	22	10
E 8	9.8	12	7	40	50	25	10
E10	11.6	12	8.2	40	50	29	10

2350M (mm)	D ₁ (mm)	D ₂ (mm)	ℓ (mm)	H (mm)	L (mm)	(g)	(pcs.)
8	12.3	11.2	5	40	50	30	10
10	14.2	12.9	6	39	50	35	10
12	17.3	16	7	39	50	55	10
14	19.9	18	8.5	38	50	70	10

2440M 2445M (mm)	D ₁ (mm)	D ₂ (mm)	ℓ (mm)	L (mm)	(g)	(pcs.)
4	6.7	13	4.8	31.5	17	10
5	8	13	5.3	32	17	10
6	9.2	13	6.1	33	18	10
7	10.5	13	6.5	33	19	10
8	11.7	13	7	34	19	10
9	13	13	7	34	20	10
10	14.2	13	8.3	35	20	10
11	15.5	13	9.5	36	21	10
12	16.7	13	10	37	21	10
13	18	13	10.5	37	26	10
14	19.2	13	10.5	37	28	10

2440A 2445A (inch)	D ₁ (mm)	D ₂ (mm)	ℓ (mm)	L (mm)	(g)	(pcs.)
1/4	9.8	13	6.5	33	18	10
5/16	11.7	13	7	34	19	10
3/8	13.7	13	8.3	35	20	10
7/16	15.5	13	9.5	36	21	10
1/2	18	13	10.5	37	26	10
9/16	19.2	13	10.5	37	28	10

2445A (inch)	D ₁ (mm)	D ₂ (mm)	ℓ (mm)	L (mm)	(g)	(pcs.)
3/16	8	13	5.3	32	18	10
1/4	9.8	13	6.5	33	18	10
9/32	10.5	13	6.5	33	19	10
5/16	11.7	13	7	34	19	10
11/32	13	13	7	34	20	10
3/8	13.7	13	8.3	35	20	10
7/16	15.5	13	9.5	36	21	10
1/2	18	13	10.5	37	26	10
9/16	19.2	13	10.5	37	28	10

RS2445A/9	9 Pieces set/Rail 150mm	(g)
3/16, 1/4, 9/32, 5/16, 11/32, 3/8, 7/16, 1/2, 9/16		220

AS2445A (inch)	D ₁ (mm)	D ₂ (mm)	ℓ (mm)	L (mm)	(g)	(pcs.)
1/4	9.6	12.9	5.7	31.8	18	10
5/16	11.7	12.9	7	34.6	21	10
3/8	13.5	12.9	8.3	35.1	21	10
7/16	15.5	12.9	9.5	39.1	25	10
1/2	17.2	12.9	10.5	40.1	27	10

Aerospace Standard SAE AS954
Norma Aeroespacial SAE AS954

2440T (E)	D ₁ (mm)	D ₂ (mm)	ℓ (mm)	L (mm)	(g)	(pcs.)
E 6	8	13	5.4	31.9	20	10
E 8	9.8	13	7	33.1	20	10
E10	11.7	13	8.2	33.6	21	10
E12	14.2	13	9.3	35.1	24	10

2441M (mm)	D ₁ (mm)	D ₂ (mm)	ℓ (mm)	L (mm)	(g)	(pcs.)
7	11.3	13	4	33	19	10
8	12.3	13	5	32	19	10
10	14.5	13	6	32.5	21	10
12	16.8	13	7	34	21	10
13	18	13	8	35	21	10
14	20	13	8.5	37	28	10

2440M · 2440A 6-point Universal Sockets Vasos Hexagonales con Articulación Universal

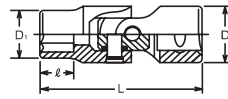

2445M · 2445A 12-point Universal Sockets Vasos Bihexagonales con Articulación Universal

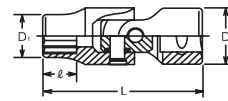

RS2445A/9 Socket Set on Rail Juego de Vasos en Regleta



AS2445A 12-point Universal Sockets, AS954 Vasos Bihex con Articulación Universal, AS954

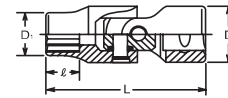

2440T TORX® Universal Sockets Vasos TORX® con Articulación Universal

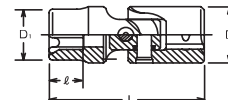

2441M Nut Grip® Universal Sockets Vasos Sujeta-Tuercas con Articulación Universal

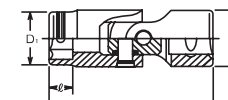

Hand Sockets 1/4"

HAND
MANUALES

Z-SERIES

TITANIUM
DE TITANIO

SCREWDRIVERS
DESTORNILLADORES

IMPACT
DE IMPACTO

SLEEVE-DRIVE

INDUSTRIAL
INDUSTRIALES

PROTECTOR
PROTECTORES



AUTOMOTIVE

RENEWAL KITS
JUEGOS DE PIEZAS REPUESTO

CONSTRUCTION
CONSTRUCCIÓN

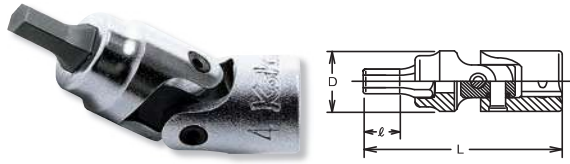

2430M Universal Inhex Sockets Vasos Hexagonales con Articulación Universal



2430M (mm)	D (mm)	ℓ (mm)	L (mm)	 (g)	 (pcs.)
3	13	5,5	40	18	10
4	13	5,5	40	18	10
5	13	6,5	40	20	10
6	13	7,5	40	21	10

2430T TORX® Universal Sockets Vasos TORX® con Articulación Universal



2430T (T)	D (mm)	L (mm)	 (g)	 (pcs.)
T 8	13	42	22	10
T 9	13	42	22	10
T10	13	42	22	10
T15	13	42	22	10
T20	13	42	22	10
T25	13	42	22	10
T27	13	42	22	10
T30	13	42	22	10

2000-28 (PH) Phillips Bit Sockets Vasos con Punta Phillips



2000.28 (PH)	D (mm)	H (mm)	L (mm)	 (g)	 (pcs.)
1	11,9	12	28	10	10
2	11,9	12	28	11	10
3	11,9	12	28	12	10
4	13,1	11	28	14	10



2000-28 (PZ) PZ Bit Sockets Vasos con Punta PZ



2000.28 (PZ)	D (mm)	H (mm)	L (mm)	 (g)	 (pcs.)
PZ1	11,9	12	28	10	10
PZ2	11,9	12	28	11	10
PZ3	11,9	12	28	12	10

2005-25 Slotted Bit Sockets Vasos con Punta Recta para Cabeza Ranurada



2005.25	TxW (mm)	D (mm)	H (mm)	L (mm)	 (g)	 (pcs.)
3	0,5x 3	11,9	9	25	9	10
4	0,8x 4	11,9	9	25	10	10
5	1,0x 5,5	11,9	9	25	10	10
6	1,2x 6,5	13,1	9	25	11	10
8	1,2x 8	13,1	9	25	12	10
9	1,6x 8	13,1	9	25	12	10
10	1,6x10	14,3	9	25	13	10

1/4" Hand Sockets

2010M.25 (mm)	D (mm)	H (mm)	L (mm)	(g)	(pcs.)
1.5	11.9	9	25	9	10
2	11.9	9	25	9	10
2.5	11.9	9	25	9	10
3	11.9	9	25	9	10
4	11.9	9	25	9	10
5	11.9	9	25	10	10
6	11.9	9	25	12	10
7	13.1	8	25	12	10
8	13.1	8	25	14	10
10	14.3	8	25	17	10

2010M.100 (mm)	D (mm)	H (mm)	L (mm)	(g)	(pcs.)
2	11.9	84	100	30	10
2.5	11.9	84	100	30	10
3	11.9	84	100	30	10
4	11.9	84	100	30	10
5	13.1	83	100	30	10
6	13.1	83	100	35	10
7	13.1	83	100	35	10
8	13.1	83	100	38	10
10	14.3	83	100	45	10

2010A.25 (inch)	D (mm)	H (mm)	L (mm)	(g)	(pcs.)
1/8	11.9	9	25	9	10
5/32	11.9	9	25	9	10
3/16	11.9	9	25	10	10
7/32	11.9	9	25	11	10
1/4	11.9	9	25	12	10
9/32	13.1	8	25	12	10
5/16	13.1	8	25	14	10
3/8	14.3	8	25	17	10

RS2010M/7-L25	7 Pieces set/Rail 150mm	(g)
3, 4, 5, 6, 7, 8, 10		115

RS2010A/8-L25	8 Pieces set/Rail 150mm	(g)
1/8, 5/32, 3/16, 7/32, 1/4, 9/32, 5/16, 3/8		130

2011M.50 (mm)	D (mm)	H (mm)	L (mm)	(g)	(pcs.)
3	11.9	34	50	16	10
4	11.9	34	50	17	10
5	11.9	34	50	18	10
6	11.9	34	50	18	10

 Ball point bit sockets have less strength due to the special design. Make sure to use them correctly.



2010M-25 · -100 2010A-25

 Inhex Bit Sockets
Vasos con Punta Hexagonal

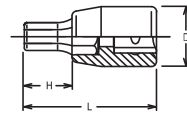

RS2010M/7-L25 RS2010A/8-L25

  Socket Set on Rail
Juego de Vasos en Regleta



2011M-50

 Ballpoint Inhex Bit Sockets
Vasos con Punta de Bola Inhex 

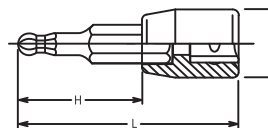

HAND
MANUALES
Z-SERIES
TITANIUM
DE TITANIO
ACCESSORIES
ACCESORIOS
SCREWDRIVERS
DESTORNILLADORES
IMPACT
DE IMPACTO
SLEEVE-DRIVE
INDUSTRIAL
INDUSTRIALES
PROTECTOR
PROTECTORES
AUTOMOTIVE
CONSTRUCTION
CONSTRUCCIÓN
RENEWAL KITS
JUEGOS DE PIEZAS REPUESTO

Hand Sockets 1/4"

2020-28 • -50

XZN Bit Sockets
Vasos con Punta XZN

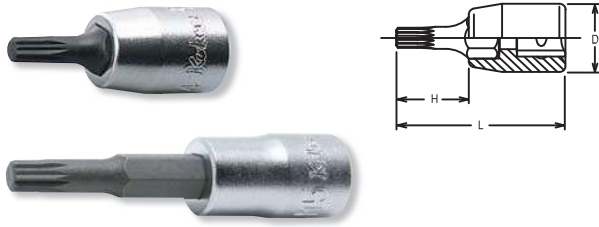

2020.28 (XZN)	D (mm)	H (mm)	L (mm)	(g)	(pcs.)
M4	11.9	12	28	12	10
M5	11.9	12	28	12	10
M6	11.9	12	28	13	10
M8	13.1	11	28	14	10

2020.50 (XZN)	D (mm)	H (mm)	L (mm)	(g)	(pcs.)
M4	11.9	34	50	20	10
M5	11.9	34	50	20	10
M6	11.9	34	50	22	10
M8	13.1	33	50	24	10

2025-28 • -80 (T)

TORX® Bit Sockets
Vasos con Punta TORX®

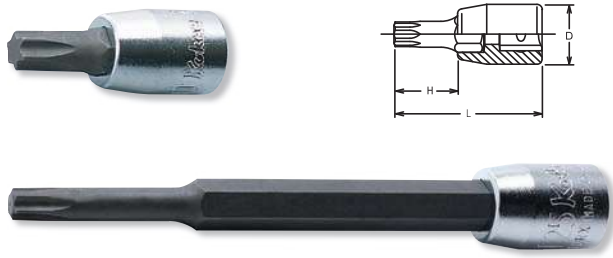

2025.28 (T)	D (mm)	H (mm)	L (mm)	(g)	(pcs.)
T 8	11.9	12	28	10	10
T 9	11.9	12	28	10	10
T10	11.9	12	28	10	10
T15	11.9	12	28	10	10
T20	11.9	12	28	11	10
T25	11.9	12	28	11	10
T27	11.9	12	28	12	10
T30	11.9	12	28	12	10
T40	11.9	12	28	13	10

2025.80 (T)	D (mm)	H (mm)	L (mm)	(g)	(pcs.)
T10	11.9	64	80	40	10
T15	11.9	64	80	40	10
T20	11.9	64	80	42	10
T25	11.9	64	80	42	10
T27	11.9	64	80	45	10
T30	11.9	64	80	45	10
T40	11.9	64	80	50	10

TORX®
(T)

T	T8	T9	T10	T15	T20	T25	T27	T30	T40	T45	T50	T55	T60	T70	T80	T90	T100
S (ref. mm)	2.30	2.48	2.72	3.26	3.84	4.40	4.96	5.49	6.60	7.77	8.79	11.17	13.20	15.49	17.51	19.88	22.09

RS2025/7-L28

Socket Set on Rail
Juego de Vasos en Regleta



RS2025/7-L28	7 Pieces set/Rail 150mm	(g)
T10, T15, T20, T25, T27, T30, T40		119

2025-28 (TH)

Tamper-Resistant TORX® Bit Sockets
Vasos con Punta TORX® Indeformable



2025.28 (TH)	D (mm)	H (mm)	L (mm)	(g)	(pcs.)
T10H	11.9	12	28	10	10
T15H	11.9	12	28	10	10
T20H	11.9	12	28	11	10
T25H	11.9	12	28	11	10
T27H	11.9	12	28	12	10
T30H	11.9	12	28	12	10
T40H	11.9	12	28	13	10

RS2025/7-HOLE

Socket Set on Rail
Juego de Vasos en Regleta



RS2025/7-HOLE	7 Pieces set/Rail 150mm	(g)
T10H, T15H, T20H, T25H, T27H, T30H, T40H		119

Tamper Resistant TORX® Bit Sockets have less strength due to special design. Make sure to use it correctly.

Los Vasos con Punta Indeformable TORX® tienen menos resistencia debido al diseño especial. Asegurarse de su correcta utilización.



1/4" Hand Sockets

2025,28 (IP)	D (mm)	H (mm)	L (mm)	(g)	(pcs.)
8IP	11.9	12	28	10	10
9IP	11.9	12	28	10	10
10IP	11.9	12	28	10	10
15IP	11.9	12	28	10	10
20IP	11.9	12	28	11	10
25IP	11.9	12	28	11	10
27IP	11.9	12	28	12	10
30IP	11.9	12	28	12	10
40IP	11.9	12	28	13	10

2025-28 (IP)



TORX PLUS® Bit Sockets
Vasos con Punta TORX PLUS®

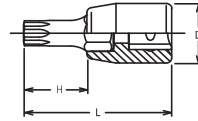

TORXplus® (IP)



IP	8IP	9IP	10IP	15IP	20IP	25IP	27IP	30IP	40IP	45IP	50IP	55IP	60IP	70IP	
S	(ref. mm)	2.29	2.48	2.72	3.25	3.84	4.39	4.95	5.49	6.60	7.77	8.79	11.16	13.20	15.49

RS2025/7-IP	7 Pieces set/Rail 150mm	(g)
10IP, 15IP, 20IP, 25IP, 27IP, 30IP, 40IP		119

RS2025/7-IP



Socket Set on Rail
Juego de Vasos en Regleta



2025,28 (PR)	D (mm)	H (mm)	L (mm)	(g)	(pcs.)
8PR	11.9	12	28	10	10
9PR	11.9	12	28	10	10
10PR	11.9	12	28	10	10
15PR	11.9	12	28	10	10
20PR	11.9	12	28	11	10
25PR	11.9	12	28	11	10
27PR	11.9	12	28	12	10
30PR	11.9	12	28	12	10
40PR	13.1	12	28	13	10

2025-28 (PR)



Penta-Lobe Bit Sockets, with Hole
Vasos con Punta de Cinco Lóbulos, con agujero

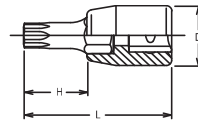

Penta-Lobe (PR)



PR	8PR	9PR	10PR	15PR	20PR	25PR	27PR	30PR	40PR	45PR	50PR	55PR	
S	(ref. mm)	2.19	2.36	2.58	3.10	3.64	4.12	4.71	5.23	6.30	7.38	8.35	10.63

RS2025/7-PR	7 Pieces set/Rail 150mm	(g)
10PR, 15PR, 20PR, 25PR, 27PR, 30PR, 40PR		119

RS2025/7-PR



Socket Set on Rail
Juego de Vasos en Regleta



Hand Sockets 1/4"

HAND
MANUALES

Z-SERIES

TITANIUM
DE TITANIO

ACCESSORIES
ACCESORIOS

SCREWDRIVERS
DESTORNILLADORES

IMPACT
DE IMPACTO

SLEEVE-DRIVE

INDUSTRIAL
INDUSTRIALES

PROTECTOR
PROTECTORES

AUTOMOTIVE

CONSTRUCTION
CONSTRUCCIÓN

RENEWAL KITS
JUEGOS DE PIEZAS REFUESTO

2753PS Reversible Ratchet Short
Llave de Carraca Reversible Corta

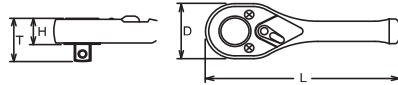

* Renewal Kits → 2753RK → P286

	D (mm)	T (mm)	H (mm)	L (mm)	(g)	(pcs.)
2753PS	22	18.7	11.4	75	55	5

2753N Reversible Ratchet
Llave de Carraca Reversible



* Renewal Kits → 2753RK → P286

2753P Reversible Ratchet
Llave de Carraca Reversible



* Renewal Kits → 2753RK → P286

2753J Reversible Ratchet
Llave de Carraca Reversible

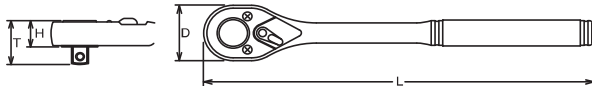

* Renewal Kits → 2753RK → P286

	D (mm)	T (mm)	H (mm)	L (mm)	(g)	(pcs.)
2753N	22	18.7	11.4	115	90	10
2753P	22	18.7	11.4	115	87	10
2753J	22	18.7	11.4	115	77	5

2753P-160 Reversible Ratchet Long
Llave de Carraca Reversible Larga

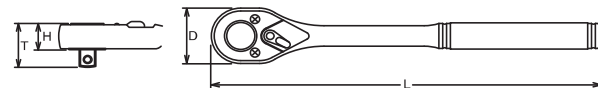

* Renewal Kits → 2753RK → P286

	D (mm)	T (mm)	H (mm)	L (mm)	(g)	(pcs.)
2753P-160	22	18.7	11.4	160	107	5

1/4" Hand Sockets

HAND MANUALES
Z-SERIES
TITANIUM DE TITANIO
ACCESSORIES ACCESORIOS
SCREWDRIVERS DESTORNILLADORES
IMPACT DE IMPACTO
SLEEVE-DRIVE INDUSTRIAL INDUSTRIALES
PROTECTOR PROTECTORES
AUTOMOTIVE
CONSTRUCTION CONSTRUCCIÓN
RENEWAL KITS JUEGOS DE PIEZAS REPUESTO



* Renewal Kits → 2753BRK → P286



* Renewal Kits → 2753BRK → P286



* Renewal Kits → 2753BRK → P286

	D (mm)	T (mm)	H (mm)	L (mm)	(g)	(pcs.)
2753NB	22	18.7	11.4	115	90	10
2753PB	22	18.7	11.4	115	87	10
2753JB	22	18.7	11.4	115	77	5

⚠ Reversible Ratchet with quick release button has less strength compared with normal ratchet due to the technical design. Make sure to use the ratchet correctly.



* Renewal Kits → 2752RK → P286

	D (mm)	T (mm)	H (mm)	L (mm)	(g)	(pcs.)
2752N	26.5	19.8	12.5	125	95	10



* Renewal Kits → 2753RK → P286



* Renewal Kits → 2753RK → P286

	D (mm)	T (mm)	H (mm)	L (mm)	(g)	(pcs.)
2774PS	22	18.7	11.4	116	110	5
2774JS	22	18.7	11.4	116	113	5

2753NB Reversible Ratchet with Quick Release Button Llave de Carraca Reversible con botón de extracción rápida ⚠



2753PB Reversible Ratchet with Quick Release Button Llave de Carraca Reversible con botón de extracción rápida ⚠



2753JB Reversible Ratchet with Quick Release Button Llave de Carraca Reversible con botón de extracción rápida ⚠

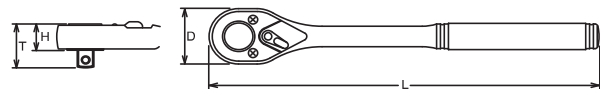

2752N Reversible Ratchet Llave de Carraca Reversible

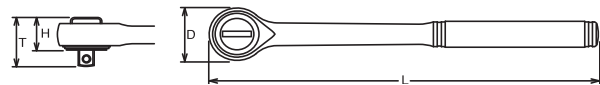

2774PS Flexible Ratchet, Reversible Llave de Carraca Flexible, Reversible



2774JS Flexible Ratchet, Reversible Llave de Carraca Flexible, Reversible



Hand Sockets 1/4"

HAND
MANUALES

Z-SERIES

TITANIUM
DE TITANIO

ACCESSORIES
ACCESORIOS

SCREWDRIVERS
DESTORNILLADORES

IMPACT
DE IMPACTO

SLEEVE-DRIVE
SLEEVES

INDUSTRIAL
INDUSTRIALES

PROTECTOR
PROTECTORES

AUTOMOTIVE

CONSTRUCTION
CONSTRUCCIÓN

RENEWAL KITS
JUEGOS DE PIEZAS REPUESTO

2774N Flexible Ratchet, Reversible
Llave de Carraca Flexible, Reversible



* Renewal Kits → 2753RK → P286

2774P Flexible Ratchet, Reversible
Llave de Carraca Flexible, Reversible



* Renewal Kits → 2753RK → P286

2774J Flexible Ratchet, Reversible
Llave de Carraca Flexible, Reversible



* Renewal Kits → 2753RK → P286

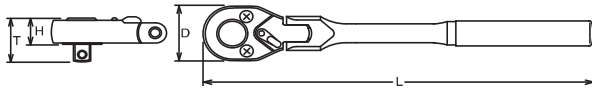

	D (mm)	T (mm)	H (mm)	L (mm)	(g)	(pcs.)
2774N	22	18.7	11.4	161	130	2
2774P	22	18.7	11.4	161	126	2
2774J	22	18.7	11.4	161	130	2

2755 Ratchet Adaptor
Adaptador de carraca

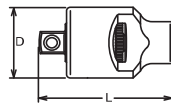

* Renewal Kits → 2755RK → P286

	D (mm)	L (mm)	(g)	(pcs.)
2755	26	40	80	10

2756 Quick Spinner
Disco de giro Rápido

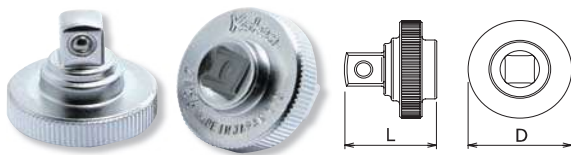

	D (mm)	L (mm)	(g)	(pcs.)
2756	22	20	19	10

2762 Flexible Extension Bar
Alargadera Flexible

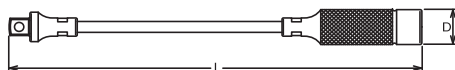

	D (mm)	L (mm)	(g)	(pcs.)
2762	13	300	90	2

2760	D (mm)	L (mm)	(g)	(pcs.)
28	12.3	28	14	10
50	12.3	50	23	10
75	12.3	75	35	10
100	12.3	100	44	10
150	12.3	150	63	10
200	12.3	200	83	10
250	12.3	250	103	10
300	12.3	300	122	2
350	12.3	350	145	2
400	12.3	400	160	2
600	12.3	600	240	2

PK2760/6	6 Pieces Set/Δ=430g
PLASTIC TRAY	
Extension Bars	
2760 Extension Bars 28, 50, 100, 150, 200, 250	



2763	D (mm)	L (mm)	(g)	(pcs.)
28	12.3	28	14	10
50	12.3	50	23	10
75	12.3	75	33	10
100	12.3	100	43	10
150	12.3	150	62	10
200	12.3	200	80	10
250	12.3	250	100	10

PK2763/6	6 Pieces Set/Δ=420g
PLASTIC TRAY	
Extension Bars	
2763 Wobble-Fix Extension Bar 28, 50, 100, 150, 200, 250	

Wobble-Fix Extension Bar
Two way usage : One for as a flexible extension bar to provide at 15° angle operation, the other for use as a normal extension bar. This usage is Patent.

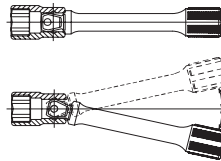

Alargadera Articulada-Fija
Dos formas de utilización : Una como alargadera flexible para poder trabajar con un ángulo de 15° y otra para utilizarse como alargadera normal. Esta aplicación está patentada.

The Wobble-Fix Extension Bar has less strength than normal extension bar due to it's specific design with a reduced square drive. Make sure to use it correctly.

* Renewal Kits → 2768RK → P288

* Renewal Kits → 2768RK → P288

* Renewal Kits → 2768RK → P288

	D (mm)	L (mm)	(g)	(pcs.)
2768N	14	130	86	10
2768P	14	130	70	10
2768J	14	130	73	5

2760-28 · -50 · -75 · -100 · -150 · -200 · -250 · -300 · -350 · -400 · -600

Extension Bars
Alargaderas

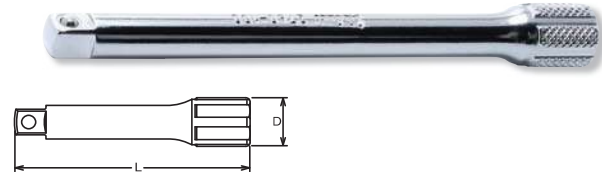

PK2760/6 Set Juego



2763-28 · -50 · -75 · -100 · -150 · -200 · -250

Wobble-Fix Extension Bars
Alargaderas Articuladas-Fijas

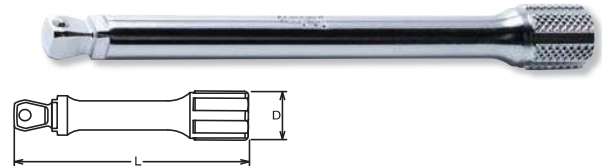

PK2763/6 Set Juego



2768N Hinge Handle Mango Articulado



2768P Hinge Handle Mango Articulado



2768J Hinge Handle Mango Articulado

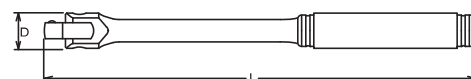

Hand Sockets 1/4"

HAND
MANUALES

Z-SERIES

TITANIUM
DE TITANIO

ACCESSORIES
ACCESORIOS

SCREWDRIVERS
DESTORNILLADORES

IMPACT
DE IMPACTO

SLEEVE-DRIVE

INDUSTRIAL
INDUSTRIALES

PROTECTOR
PROTECTORES

AUTOMOTIVE

CONSTRUCTION
CONSTRUCCIÓN

RENEWAL KITS
JUEGOS DE PIEZAS REPUESTO

2769N-150 • -220 Spin Type Handle Mango Tipo Destornillador ⚠

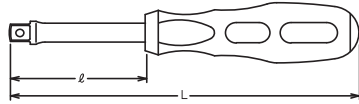

2769N	ℓ (mm)	L (mm)	(g)	(pcs.)
150	50	150	68	2
220	120	220	100	2

⚠ Plastic or rubber handles are not intended to act as insulation.
Los mangos de plástico o de goma no están previstos para aislamiento.

2769NWF-150 • -220 Spin Type Handle(Wobble-Fix) Mango Tipo Destornillador Articulados-Fijos ⚠

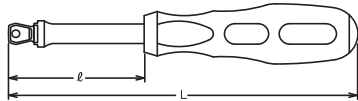

2769NWF	ℓ (mm)	L (mm)	(g)	(pcs.)
150	50	150	68	2
220	120	220	100	2

Wobble-Fix Extension Bar

Two way usage : One for as a flexible extension bar to provide at 15° angle operation, the other for use as a normal extension bar. This usage is Patent.

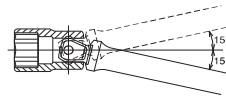
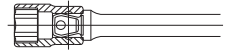

Alargadera Articulada-Fija

Dos formas de utilización : Una como alargadera flexible para poder trabajar con un ángulo de 15° y otra para utilizarse como alargadera normal. Esta aplicación está patentada.

2769F Spin Type Handle Mango Tipo Destornillador

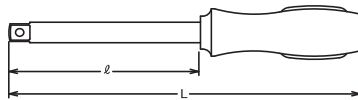

2769F	ℓ (mm)	L (mm)	(g)	(pcs.)
2769F	78	150	90	5

2769H Folding Socket Driver Llave de Vaso Plegable

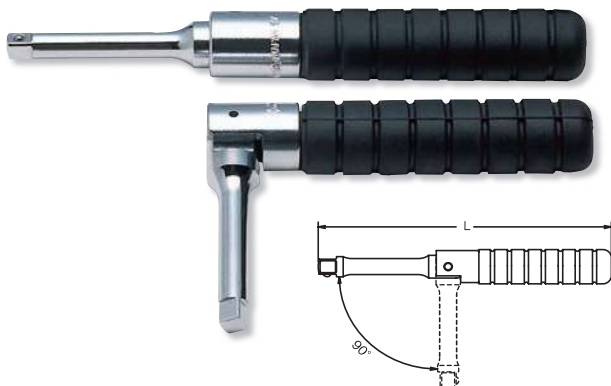

2769H	L (mm)	(g)	(pcs.)
2769H	160	180	10

1/4" Hand Sockets

	L (mm)	⚖️ (g)	📦 (pcs.)
2770	33	20	10
2771	31	20	10

2770 Universal Joint
Articulación Universal

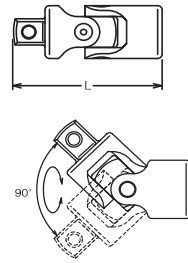

2771 Universal Joint
Articulación Universal

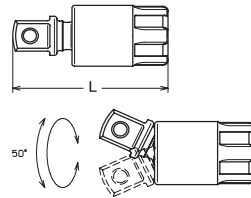

	L (mm)	⚖️ (g)	📦 (pcs.)
2780	350	250	1

2780 Speed Handle
Manivela Rápida

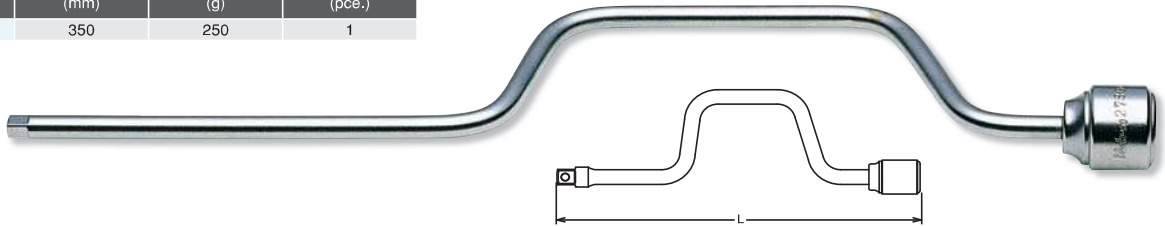

2785 T-Handle
Mango Corredizo



	L (mm)	⚖️ (g)	📦 (pcs.)
2785	115	36	10

	☐ (sq.)	☐ (sq.)	L (mm)	⚖️ (g)	📦 (pcs.)
2233A	1/4"	3/8"	22	16	10

2233A Adaptor
Adaptador

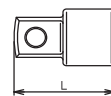

HAND
MANUALES

Z-SERIES

TITANIUM
DE TITANIO

ACCESSORIES
ACCESORIOS

SCREWDRIVERS
DESTORNILLADORES

IMPACT
DE IMPACTO

SLEEVE-DRIVE

INDUSTRIAL
INDUSTRIALES

PROTECTOR
PROTECTORES

AUTOMOTIVE

CONSTRUCTION
CONSTRUCCIÓN

RENEWAL KITS
JUEGOS DE PIEZAS REPUESTO

Hand Sockets 1/4"

HAND
MANUALES

Z-SERIES

TITANIUM
DE TITANIO

ACCESSORIES
ACCESORIOS

SCREWDRIVERS
DESTORNILLADORES

IMPACT
DE IMPACTO

SLEEVE-DRIVE

INDUSTRIAL
INDUSTRIALES

PROTECTOR
PROTECTORES

AUTOMOTIVE

RENEWAL KITS
JUEGOS DE PIEZAS REEMPLAZO

CONSTRUCTION
CONSTRUCCIÓN

2201AM Socket Set Juego de Vasos



2201AM		25 Pieces Set/△=870g
METAL CASE:W240xH100xT32mm		
Sockets	Accessories	
<p> 2400M 6-pt. Sockets 4, 5, 5.5, 6, 7, 8, 9, 10, 11, 12, 13</p> <p> 2400A 6-pt. Sockets 3/16, 7/32, 1/4, 9/32, 5/16, 11/32, 3/8, 7/16, 1/2</p>	<p> 2753N</p> <p> 2760-100</p> <p> 2769N-150</p> <p> 2770</p> <p> 2785</p>	

2203M • 2203A Socket Set Juego de Vasos



2203M		12 Pieces Set/△=550g
METAL CASE:W160xH100xT28mm		
Sockets	Accessories	
<p> 2400M 6-pt. Sockets 4, 4.5, 5, 5.5, 6, 7, 8, 9, 10, 11, 13</p>	<p> 2769H</p>	
2203A		10 Pieces Set/△=550g
METAL CASE:W160xH100xT28mm		
Sockets	Accessories	
<p> 2400A 6-pt. Sockets 3/16, 7/32, 1/4, 9/32, 5/16, 11/32, 3/8, 7/16, 1/2</p>	<p> 2769H</p>	

2250M • 2250A Socket Set Juego de Vasos









2250M		16 Pieces Set/△=700g
METAL CASE:W160xH100xT28mm		
Sockets	Accessories	
<p> 2400M 6-pt. Sockets 5, 6, 7, 8, 9, 10, 11, 12</p> <p> 2415M Double Square Sockets 8, 10</p>	<p> 2753N</p> <p> 2760-50</p> <p> 2760-150</p> <p> 2768N</p> <p> 2770</p> <p> 2785</p>	

2250A		16 Pieces Set/△=700g
METAL CASE:W160xH100xT28mm		
Sockets	Accessories	
<p> 2400A 6-pt. Sockets 7/32, 1/4, 9/32, 5/16, 11/32, 3/8, 7/16</p> <p> 2415A Double Square Sockets 1/4, 5/16, 3/8</p>	<p> 2753N</p> <p> 2760-50</p> <p> 2760-150</p> <p> 2768N</p> <p> 2770</p> <p> 2785</p>	

2254M Bit Set Juego de Puntas



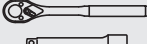

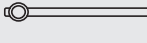
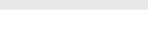





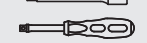

2254M		12 Pieces Set/△=450g
METAL CASE:W160xH100xT28mm		
Bits	Accessories	
<p> 101P Phillips Bits 1, 2, 3</p> <p> 101S Slotted Bits 1x7, 1.2x7</p> <p> 101H Hex Bits 3, 4, 5</p>	<p> 102NA-1/4x5/16</p> <p> 2769F</p> <p> 101A</p> <p> 2137</p>	

2257M 31 Pieces Set/SET=930g	
METAL CASE:W240xH100xT32mm	
Sockets	Accessories
<p> 2400M 6-pt. Sockets 4, 4.5, 5, 5.5, 6, 7, 8, 9, 10, 11, 12</p> <p> 2000.28 Bit Sockets 1, 2, 3, 4</p> <p> 2005.25 Bit Sockets 4, 5, 6, 8, 9</p> <p> 2010M.25 Bit Sockets 3, 4, 5, 6, 8, 10</p>	<p> 2753N</p> <p> 2760-100</p> <p> 2769N-150</p> <p> 2770</p> <p> 2785</p>

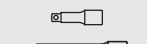

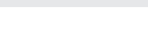

2257M Socket Set
Juego de Vasos



2260M 28 Pieces Set/SET=2,370g	
METAL CASE: W370xH150xT50mm	
Sockets	Accessories
<p> 2400M 6-pt. Sockets 4, 5, 5.5, 6, 7, 8, 10, 12</p> <p> 3400M 6-pt. Sockets 8, 10, 11, 12, 13, 14, 15, 17, 18, 19, 21</p>	<p> 2753N</p> <p> 2760-50</p> <p> 2760-100</p> <p> 2769N-150</p> <p> 3749N</p> <p> 3760-75</p> <p> 3760-125</p> <p> 3785</p> <p> 3322A</p>

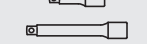
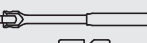
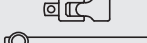
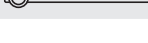

2260M Socket Set
Juego de Vasos



2261M 17 Pieces Set/SET=690g	
METAL CASE:W192xH122xT30mm	
Sockets	Accessories
<p> 2400M 6-pt. Sockets 4, 4.5, 5, 5.5, 6, 7, 8, 9, 10, 11, 12</p>	<p> 2753N</p> <p> 2760-50</p> <p> 2760-150</p> <p> 2768N</p> <p> 2770</p> <p> 2785</p>

2261M Socket Set
Juego de Vasos



2262M 13 Pieces Set/SET=470g	
METAL CASE:W160xH100xT28mm	
Sockets	Accessories
<p> 2400M 6-pt. Sockets 4, 4.5, 5, 5.5, 6, 7, 8, 9, 10, 11, 12</p>	<p> 2760-50</p> <p> 2768N</p>

2262M Socket Set
Juego de Vasos



2274M 7 Pieces Set/SET=245g	
PLASTIC BAG	
Sockets	

 **2300M** 6-pt. Deep Sockets
6, 7, 8, 9, 10, 11, 12

2274A 7 Pieces Set/SET=245g	
PLASTIC BAG	
Sockets	

 **2300A** 6-pt. Deep Sockets
1/4, 9/32, 5/16, 11/32, 3/8, 7/16, 1/2

2274M · 2274A Socket Set
Juego de Vasos



Hand Sockets 1/4"

HAND
MANUALES

Z-SERIES

TITANIUM
DE TITANIO

ACCESSORIES
ACCESORIOS

SCREWDRIVERS
DESTORNILLADORES

IMPACT
DE IMPACTO

SLEEVE-DRIVE

INDUSTRIAL
INDUSTRIALES

PROTECTOR
PROTECTORES

AUTOMOTIVE

CONSTRUCTION
CONSTRUCCIÓN

RENEWAL KITS
JUEGOS DE PIEZAS REPUESTO

2275 Sockets Set Juego de Vasos



2275		19 Pieces Set/△=880g
METAL CASE:W192xH122xT30mm		
Sockets	Accessories	
<ul style="list-style-type: none"> 2400M 6-pt. Sockets 5.5, 6, 7, 8, 10, 12, 13 2000.28 Bit Sockets 1, 2, 3 2005.25 Bit Sockets 6, 8 2010M.25 Bit Sockets 3, 4, 5, 6 		2753N
		2763-50
		2769N-150

2276 Sockets Set with Bits and Accessories Juego de vasos con Puntas y Accesorios



2276		19 Pieces Set/△=640g
METAL CASE:W192xH122xT30mm		
Bits	Accessories	
<ul style="list-style-type: none"> 108P Phillips Bits 1, 2, 3 108S Slotted Bits 4, 5, 6 108H Hex Bits 3, 4, 5, 6 108T TORX® Bits T10, T15, T20, T25, T27, T30 		2753PS
		2769N-150
		2137

2277 Sockets Set Juego de Vasos



2277		21 Pieces Set/△=1,240g
METAL CASE:W310xH90xT48mm		
Sockets	Accessories	
<ul style="list-style-type: none"> 2400M 6-pt. Sockets 5.5, 6, 7, 8, 9, 10, 11, 12, 13 2300M 6-pt. Deep Sockets 5.5, 6, 7, 8, 9, 10, 11, 12, 13 		2753N
		2763-75
		2769N-150



2277A-12P Sockets Set Juego de Vasos



2277A-12P		21 Pieces Set/△=1,240g
METAL CASE:W310xH90xT48mm		
Sockets	Accessories	
<ul style="list-style-type: none"> 2405A 12-pt. Sockets 7/32, 1/4, 9/32, 5/16, 11/32, 3/8, 7/16, 1/2, 9/16 2305A 12-pt. Deep Sockets 7/32, 1/4, 9/32, 5/16, 11/32, 3/8, 7/16, 1/2, 9/16 		2753N
		2763-75
		2769N-150



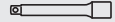

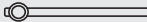
1/4" Hand Sockets

HAND MANUALES Z-SERIES TITANIUM DE TITANIO ACCESSORIES ACCESORIOS SCREWDRIVERS DESTORNILLADORES DE IMPACTO SLEEVE-DRIVE INDUSTRIAL INDUSTRIALES PROTECTOR PROTECTORES AUTOMOTIVE CONSTRUCTION CONSTRUCCIÓN RENEWAL KITS JUEGOS DE REPARACIÓN

P2201AM		25 Pieces Set/Σ=800g	
PLASTIC CASE:W245xH120xT45mm			
Sockets	Accessories		
2400M 6-pt. Sockets 4, 5, 5.5, 6, 7, 8, 9, 10, 11, 12, 13	 2753N  2760-100  2769N-150  2770  2785		
2400A 6-pt. Sockets 3/16, 7/32, 1/4, 9/32, 5/16, 11/32, 3/8, 7/16, 1/2			

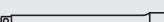
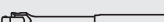

P2201AM Sockets Set
Juego de Vasos

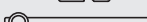

P2251M		18 Pieces Set/Σ=770g	
PLASTIC CASE:W245xH120xT45mm			
Sockets	Accessories		
2400M 6-pt. Sockets 4, 4.5, 5, 5.5, 6, 7, 8, 9, 10, 11, 12, 13	 2753N  2760-50  2760-150  2768N  2770  2785		



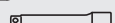

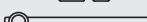
P2251M Sockets Set
Juego de Vasos



P2258M		31 Pieces Set/Σ=860g	
PLASTIC CASE:W245xH120xT45mm			
Sockets	Accessories		
2400M 6-pt. Sockets 4, 5, 5.5, 6, 7, 8, 9, 10, 11, 12, 13	 2753N  2760-100  2769N-150  2770  2785		
2000.28 Bit Sockets 1, 2, 3			
2005.25 Bit Sockets 4, 6			
2010M.25 Bit Sockets 3, 4, 5, 6, 8			
2025.28 Bit Sockets T10, T15, T20, T25, T30			

P2258M Sockets Set
Juego de Vasos

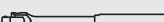

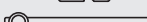
P2281A-12P		18 Pieces Set/Σ=770g	
PLASTIC CASE:W245xH120xT45mm			
Sockets	Accessories		
2405A 12-pt. Sockets 1/8, 5/32, 3/16, 7/32, 1/4, 9/32, 5/16, 11/32, 3/8, 7/16, 1/2, 9/16	 2753N  2760-50  2760-150  2768N  2770  2785		

P2281A-12P Sockets Set
Juego de Vasos



ABS Case - PE foam insert
Caja ABS - espuma polietileno